

Resolution Series® 133 & 233

Harmonic Linearizers



- ♪ The dream of musicians, engineers and music lovers has become true: the ultimate goal of being able to correct errors without negatively affecting the audio signal has finally become reality. The signal passes directly through without any negative influence possible
- ♪ Unique linearization of source signals improves reproduction of any kind of audio, AV and music system
- ♪ Can be installed in any professional or domestic system, thanks to easy in-line or "tape loop" connection
- ♪ Proprietary enhanced Class A circuitry throughout
- ♪ The FM 233 features FM ACOUSTICS' fully balanced input and output circuitry with a 100 dB interference rejection (\approx 100-1000 times better than other so-called "balanced" equipment).
- ♪ Unbalanced and pseudo-balanced signals are automatically balanced right at the input of the FM 233
- ♪ The FM 133 is for use with single-ended equipment
- ♪ Tremendous headroom and reserves in input signal handling capability (+21dBv!)
- ♪ Switchable tape loop function
- ♪ Both, the FM 133 and FM 233 can be connected to single-ended, pseudo-balanced and true balanced equipment thanks to intelligent input and output stages
- ♪ Sensors in the truly balanced outputs of the FM 233 automatically optimize performance for balanced or unbalanced loads
- ♪ Fully discrete circuitry using special curve-tracer analysed and listening-selected semiconductors
- ♪ Zero overall feedback/feed-forward
- ♪ Outputs drive practically any load and long cables with perfect stability
- ♪ No more matching problems between electronics and cables
- ♪ Special centred linearizer controls
- ♪ Extremely low impedance power supply
- ♪ Individual stabilization inside the unit close to the stages
- ♪ Hand-selected and individually matched components of DIN, IEC & MIL standard
- ♪ Modular concept, guaranteeing that the FM ACOUSTICS Harmonic Linearizers do not become obsolete

After a tremendous research program and after dozens of rejected circuit topologies, the combination of several ingenious ideas brought the final breakthrough: with the new Harmonic Linearizers of FM ACOUSTICS the improvement of any type of source signal is now possible.

The FM 133 & FM 233 are universally usable in any system and bring astounding improvements in every professional or domestic application, be it audio, film, AV.

The proprietary, true symmetrical balanced input and output stages of the *Resolution Series*® 233 set the absolute standard. These magnificent circuits allow a **much** higher accuracy of balanced signal transfer, (about 100 -1000 times 40-60dB! - better) than other usual balancing circuits.

The value of interference rejection right at the input indicates the absolutely singular rejection of signals that enter both cables symmetrically, e.g., hum interference and noise.

It expresses how strongly interference signals entering the audio lines and the circuits are attenuated. The higher the interference rejection value, the better the balancing of the circuit.

The interference rejection values of existing so-called "balanced" equipment is as low as 30-60 dB, a somewhat disappointing result not really warranting such terms as "balanced", "symmetrical" or "floating".*

Such a low interference rejection would not be acceptable, as the lines and circuits are **not** well balanced at all.

A interference rejection of at least 80-90 dB over the full frequency range is required.

Of course there are more aspects to balancing than the interference rejection alone. The quality of the interconnect cables play a very important role. Together with other characteristics, highly efficient interference shielding over a frequency band extending far into the MHz range is of highest importance.

* True balancing requires much more than just the presence of two signal lines!

What so far has been called "balanced" Linearizers have been units with simple op amp or op amp style input circuits. In such a configuration the non-inverting and inverting signal paths do not have the same electronics. The paths have different performance which in no way warrants the term "balanced". A balanced circuit must be **totally** symmetrical in relation to ground and shield.

In the typical so-called "balanced output circuits" an inverting stage is added (a circuit that inverts the output signal by 180° and feeds it to a second signal line). As two conductors and a shield are now used to transfer the signal, the layman thinks that his system is balanced. This, however, is far from a true balanced signal transfer.

It is not difficult to detect these more primitive pseudo-balanced circuits. One of the tests: if the output impedance of the **unbalanced** output is lower than that of the balanced output, it is likely that a simple phase inversion circuit is being used. Whenever an output impedance rating reads something like "Balanced 600 Ohm, Unbalanced 300 Ohm", the product is likely to just have a simple 180° phase inverter added to the unbalanced output. This is **not** a high performance symmetrical or "balanced" output and will **not** give the same performance. A simple phase inverter cannot provide a truly balanced stage.

FEATURES

- The FM 133 & FM 233 are *absolutely unique*. Any critical frequency in the audio band can be optimally linearized with just five dynamically interacting controls, all of this using FM ACOUSTICS pure discrete class A circuits.
- The FM 133 & FM 233 Linearizers can easily be connected to any system be it audio, audio-video or film. In domestic systems it is connected principally in two ways: either in-line between a preamplifier and the power amplifier (or electronic crossover in an active system) or in the tape loop of a preamplifier. In professional applications it can be inserted into any line level point or at the output of the mixer (with the added advantage of improved interfacing).
- The FM 133 & FM 233 make intelligent use of proprietary input stages. Over the full frequency range the interference rejection achieves an incredibly high rating of 100 dB! Only a few instrumentation amplifiers reach such interference rejection levels but such op-amp circuits cannot provide satisfactory audio performance. In the FM 233 such interference rejection performance is achieved with proprietary, hand-tuned, discrete enhanced Class A circuitry (no op-amps or IC's or op-amp circuitry), resulting in absolutely singular performance.
- All input impedances are absolutely linear over the full frequency range. This is the case with both balanced as well as unbalanced sources and any mixture of them.
- Signals from unbalanced sources are automatically balanced right at the input of the FM 233.
- The FM 133 & FM 233 can drive practically any load (even high capacitance loads) with perfect reproduction and absolute stability.
- The truly balanced output have sensor circuits that automatically compensate for the differences between balanced and unbalanced connections, another feature unique to FM ACOUSTICS.
- The outputs have a drive capability of up to +28 dBV. This allows to run higher signal levels and therefore achieve a better signal to noise ratio of the system.
- The FM 133 & FM 233 work optimally with **all** types of input and output circuitry of equipment. Performance variations and matching problems are a thing of the past.
- Tremendous reserves in headroom and output capability allow perfect interfacing to all professional, semipro and consumer equipment.
- The FM 133 & FM 233 easily passes the "float test" without causing any negative effect whatsoever on the other signal-carrying line. Only very few other balanced circuits will pass this floating test, which is the best indicator of the quality of balancing.
- In the FM 133 & FM 233 absolutely no overall feedback or feed-forward is employed. FM ACOUSTICS' rather ingenious, true balanced enhanced Class A stages are employed. Freedom from noise and interference are combined with absolute stability and pristine signal handling.
- A special biasing system guarantees that the *Resolution Series*® 133 & 233 does not have any form of distortion or changing tonal characteristics when warming up. It reaches its operating temperature very quickly; there is no hour long warm-up required.
- Thanks to the built-in precision power supply, the stabilisation circuits can be located close to the individual amplification stages. This reduces the power supply impedances benefiting the performance.
- Phenomenal signal to noise ratio, and freedom of hum and other non-audio signals are achieved. The FM 133 & FM 233 surpass even the best professional specifications. The amazing thing is that this is achieved with **internal** power supplies.
- There is not a single signal carrying wire in the FM 133 & FM 233. Unit to unit variations are made impossible.

* The advantage of **internal** power supplies is that there are much shorter distances between the actual supply and the amplification stages. The corresponding impedances are lower than when power supplies in separate housings are used.

- Tape/Auxiliary connection:
Even when the FM 133 is connected into the tape loop of a preamplifier it allows the tape loop function to be kept thanks to a built-in tape loop function. Furthermore, the tape monitoring switch also allows the linearized signal to be routed to the unit that is connected to the monitoring loop of the FM 133. This way it is possible to record **one's own music** selection with the Linearizer function in action. Standard recordings can be improved / remastered and then be transferred to other media*, e.g. CDR's DVD's, tapes and the like. This allows the creation of one's own collection of improved and linearized recordings.
- The FM Linearizers mechanically damped chassis design effectively isolates sensitive electronic components from induced resonances.
- Experts call the performance of the FM Linearizers "phenomenal". The built-in power supplies are shielded. Any hum, noise, magnetic or electronic interference is properly rejected and conducted to earth. This improves performance of the circuitry, as the FM 133 & FM 233 demonstrate in an unparalleled manner.
- The five Linearizer controls are precision laser trimmed and then additionally hand-selected for utmost performance. Ultra low-noise performance and superb tracking accuracy are the result.
- Each Linearizer control features a unique center bypass function using a special additional contact. This unique control allows true bypass in the center detent position.
- In addition, a BYPASS switch allows to route the signal directly from input to the output thereby bypassing the entire electronics. This is ideal for comparison purposes.
- The FM 233 allows connection to and from any balanced or unbalanced equipment. It senses the type of source and load and automatically adjusts for optimum performance with any source and any load. Unbalanced or pseudo balanced signals are automatically balanced at the inputs of the FM 233.
- All of the required interconnect cables and connectors such as RCA/Phono or XLR's are available in the Precision Interface Technology^o line. Cables for other types of connectors are available on special order basis. Contact your distributor or the factory for special requirements.
- The Swiss-made high-performance relays are hermetically sealed. Four specially coated contacts guarantee perfect operation, even after millions of switching cycles. Hermetical sealing guarantees that environmental factors cannot have a negative effect on the contacts. There is no degradation of sound quality or performance due to aging relays.
- The Resolution Series^o 133 & 233 employ proprietary controls and protection circuitry that performs various tasks:
 - Of course, delayed switch-on is incorporated. During switch-on outputs are disengaged and the Linearizer checks itself. If everything is found to be perfect, the control circuitry frees the outputs. Within ten seconds the Linearizer is fully operational.
 - Another protection circuit safeguards the Linearizer against extreme over- and undervoltages. The FM 133 & FM 233 have plenty of reserve in overvoltage, but a separate sensor also protects the units.....
 - The Resolution Series^o 133 & 233 are absolutely singular. The techniques and the ingenious circuitry are proprietary to FM ACOUSTICS.
 - The FM 133 & FM 233 will not be subject to obsolescence. Thanks to their modular construction, future breakthroughs may can be readily incorporated. By simply replacing the corresponding module (a 10 minute affair), it will be possible to keep the Harmonic Linearizers at the forefront of technology and performance.
 - The FM ACOUSTICS Harmonic Linearizers are for studio and mastering engineers and for seasoned listeners who realize that not everything that has been issued on CD, LP, DVD, Tape or other format was recorded and mastered carefully enough. Some recordings were mastered quite differently in the various countries, not to talk about the difference in pressing quality. An example: the same recordings done by the renown engineer Lewis Layton were issued in England under the Decca brand while in the USA RCA issued some of these recordings. The difference in sound comes from the preference of the mastering engineer rather than from a different recording.

The FM ACOUSTICS Harmonic Linearizers are tools, not toys.

The following pages explain the unique Linearizer section in more detail.

*There may be legal restrictions to transfer signals due to copyright issues. Before transferring, check with the relevant legal bodies in your country if any restrictions apply.

A dream come true...

FM ACOUSTICS does not like superlatives in product descriptions but without exception experts who have experienced the FM 133 & FM 233 Harmonic Linearizers have said the same: this is a revolution.

Today, the major limitations in music reproduction are the mediocre sounding sources, be they CD's, downloads, DVD's, LP's etc. Whatever the audio system, its reproduction is only as good as the source. There has been a profound lack of equipment that allows the restitution and improvement of music sources. Until now.

The FM 133 & FM 233' Harmonic Linearizers' allows precise correction and linearization of non-optimal recordings. They do this in an absolutely unique way.

LINEARIZER CIRCUITS

The FM 133 & FM 233 allow the linearization of critical frequencies. Thanks to their absolutely unique design **any** frequency (or group of frequencies) in the entire audio band can be optimised **without** negative influence on the audio signal, all of this with just five easy to adjust, dynamically interacting controls. The FM 133 & FM 233 finally provide what producers, audio engineers and music enthusiasts the world over have been dreaming about for dozens of years.

For the first time, resonances and obnoxious sounds in sources such as CD's, DVD's, LP's, tapes etc. can be attenuated (subtracted) and weakness in parts of the music spectrum can be strengthened. All this can be done whilst the characteristics and transparency of the original signal are kept pristine and while remaining purely in the analogue domain.

The improvements are described anywhere from "amazing" to "absolutely incredible".

The unique concept guarantees that all of the above is done without any negative influence on the signal path. In fact, the method of operation is rather intriguing as can be seen from Fig. C: the **entire audio signal** is directed right through from input to output avoiding any possible negative influence. The actual response improvement is done by a unique additive/subtractive bank of 5 individual Linearizers which can be combined and allow correction of any frequency aberration in the audio band. The original audio signal always passes **straight through** from the input to the output even when the strength of a band is adjusted via the linearizers controls.

While looking at the front panel of the FM 133 & FM 233 one could be reminded of an equalizer. However, the FM 133 & FM 233 Harmonic Linearizer's mode of operation is different and absolutely avoids all the problems of equalizers. The unique characteristic allow linearization of any source by only **adding or subtracting** critical areas of the audio signal to/from the *direct through* signal. This is done in a proprietary way.

The result is that in the FM 133 & FM 233 there is *no ripple* in the pass band and *no phase shift / discontinuity*, both typical problems of equalizers. The result: absolute in pristine signal coherence and superb transient response. Another singular characteristic is that, when all level controls are in full boost or attenuation position no change in response occurs; a linear gain or attenuation over the entire frequency range is achieved. This is unique, the sign of perfect linearization.

The FM 133 & FM 233 Harmonic Linearizers have been designed with optimal reproduction of *musically relevant* information in mind. Therefore, signal addition ("boost") and signal subtraction ("cut") levels are kept to an optimal but not excessive range.

To achieve this, ultra-accurate selection and extremely tight component tolerances is required. No op-amps, IC's, transformers or hybrid circuits can be used. In the tradition of FM ACOUSTICS, discrete enhanced Class A circuits are employed so that no loading, phase errors, non-linearity or other negative effect can occur.

Thanks to the FM 133 & FM 233's unique characteristics it is now possible to linearize audio signals with the assurance of only positive effects on the direct-through audio signal.

Do not try to work with the FM 133 & FM 233 like you would do with an equalizer. It does not work that way. On the FM 133 & FM 233 Linearizer section every control is dynamic, every movement of one control influences the one adjacent to do it. So it is best to set the individual controls dynamically: move one linearizer control at a time; when you hear that there is too much addition or subtraction, return the control to the point where it becomes a realistic correction. Next, move the control adjacent to it by turning that control until once again it becomes excessive. Turn it back until the setting becomes correct, then readjust the previously set control mildly until the optimum setting of these two controls is found. If needed repeat the procedure on the next control.

After an hour of practice or so users get rather comfortable with the controls and often adjust two controls simultaneously. This way they are able to control dynamically and find the optimum setting in seconds.

Even non-engineers "come to grips" rapidly with the Linearizer controls. An initial hesitation quickly reverses to enthusiasm as soon as a few recordings have been linearized.

On some recordings the linearizer controls will have to be adjusted several times during playing. The reason is that titles or movements of such works were recorded on different dates, by different engineers and sometimes even in a different location. So it is not totally uncommon to hear some quite drastic changes in sound from one title or movement to another, this on the same recording.

The special ultra accurate linearizer controls feature a special center position. This center position is not just a center click like e.g. found in usual balance controls with their lower or higher accuracy, but this center position employs a additional contact that guarantees a 100% *true bypass* at the center position. When moving the knobs it is very easy to feel the center position.

While some near perfect recordings will not need much of the linearizer function, good recordings will become greater; mediocre recordings will become very nice and some downright unlistenable recordings will become very listenable; the restitution quality is an absolute dream.

Unexpected is the astounding increase in dynamics despite that no such signal processing at all is done inside the units. When analysing why this is possible, one comes to a somewhat unexpected but quite logical explanation: as for the human hearing the apparent loudness is not a linear function, even a small subtraction or addition at certain frequencies can have a noticeable effect on the audible dynamic range.

As this depends on the contents of the musical signal - which is continuously changing - no currently established measurement can give any indication of this increase in dynamics, but its effect are instantly audible.

The FM 133 & 233 do not have a sound of their own.

A good demonstration of the inherent transparency is to first listen to the standard signal having all controls in the center detent position. Listen carefully to the all frequency ranges. Then turn one of the controls, say the 800 Hz control and while turning the control, concentrate on another frequency band, say the lower range of voices and low/mid based instruments. You will realize that when turning the 800 Hz control there is absolutely no change in the other frequency ranges! Only the frequencies that are subtracted or added are changing while the signal remains pristine and totally transparent.

In any function the entire circuitry remains non-inverting.

SIGNAL ROUTING

When the Harmonic Linearizers are connected in the tape loop and a recording device also is connected it is now for possible to record **one's own music** selection with the Linearizer function in action. Standard recordings can be improved / remastered and then be transferred to other media*, CD's, DVD's, tape machines and the like. This way the source signals can be optimised and allow the creation of one's own collection of improved and linearized recordings.*

LINEARIZER SECTION

The following figures and explanations help to better understand the results of this unique development that revolutionizes the way music is reproduced.

To appreciate the massive difference between the FM ACOUSTICS Harmonic Linearizer and filter/equalizers circuits some explanation is helpful. Fig. A shows a block schematic of a typical equalizer/filter and Fig. B shows a somewhat more detailed schematic of such a unit. One can see how the linear signal is tampered with, introducing all kinds of negative effects to the signal while trying to correct some - most often arbitrarily chosen - frequency bands that - in practical examples - are often not centered on the critical frequencies.

In Fig. A and Fig. B the filter circuits containing resistors/capacitors/coils or - even worse - active reactances are connected in the feedback loop. By changing them, the feedback configuration of the circuit is changed also! This a very is poor solution as if feedback is used, it must be linear and identical for **all** frequencies. With frequency-dependent feedback - as in such circuits - some of the music range will have much higher distortion and intermodulation than other parts of the music range.

Furthermore, it is obvious that such equalizer configurations create massive phase errors.

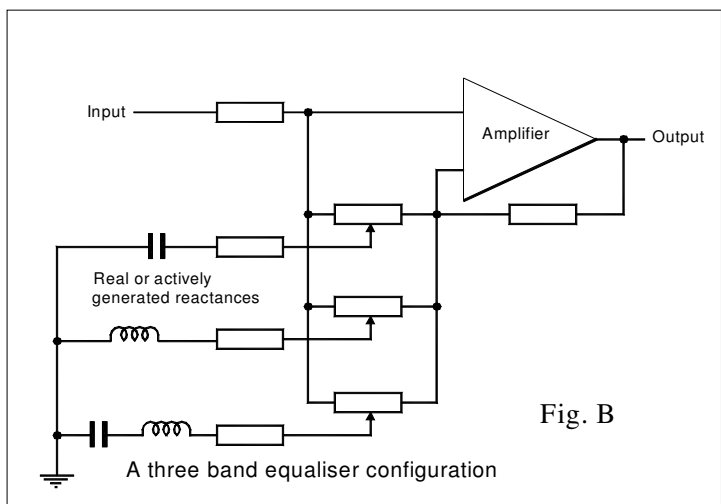
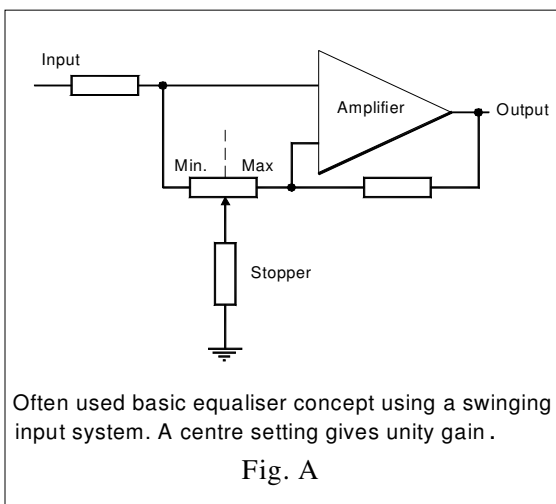

In contrast, Fig. C on the next side shows the block schematic of the FM 133 & FM 233 Linearizers. The input signal enters FM ACOUSTICS exclusive discrete Class A linear amplifier stage from which the signal goes 100% *direct-through* to the discrete Class A output amplifier. At the same time the input signal is routed to individual linearizer controls and then enters a bank of constant phase additive/subtractive linearizers. These have the unique capability of either *subtracting from or adding to* the direct-through signal without any negative influence possible! This unique system allows very fine corrections to be made without the usual drastic phase changes, frequency-dependent feedback, distortion and other negative influence on the audio signal.

The result: massive improvements in reproduction without negative influence on the audio signal!

*There may be legal restrictions to transfer signals due to copyright issues. Before transferring, check with the relevant legal bodies in your country if any restrictions apply.

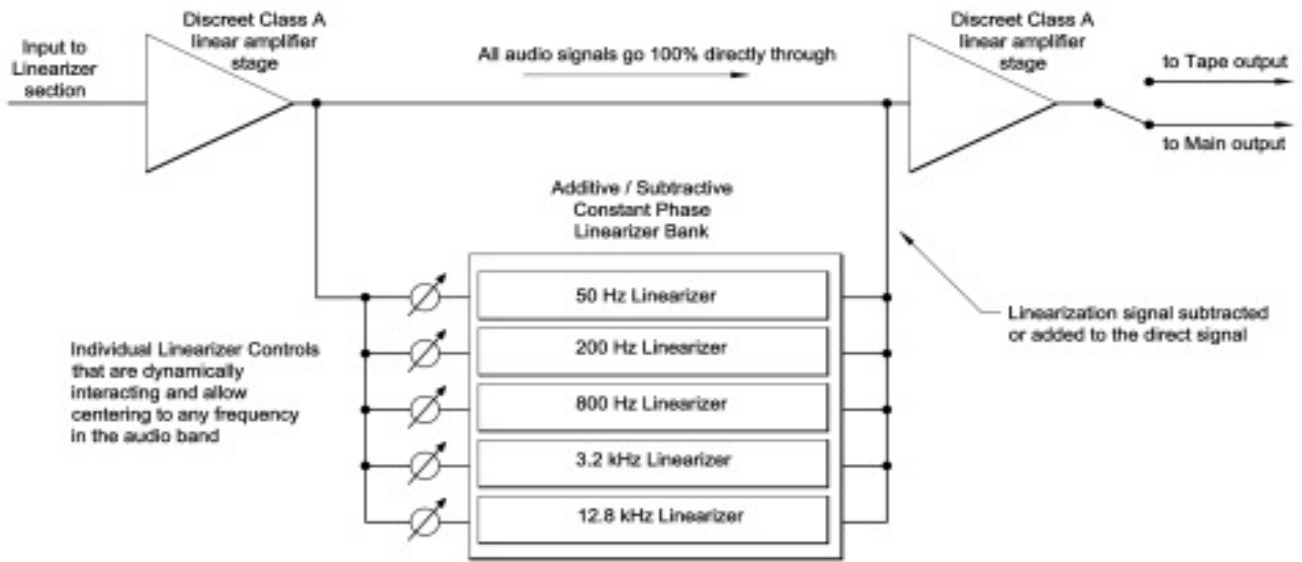

Fig. C: Block schematic of the Harmonic Linearizer showing the direct through signal and the dynamically interacting linearizers that only add to - or subtracts from - the direct through signal. The center frequencies are shown in the center position, but are continuously variable to the critical audio bands.

SYMMETRICAL / NON-SYMMETRICAL CORRECTION

On the left side of the FM 233 Linearizer there are two switches. One allows activating or bypassing the entire Linearizer section (hardwire bypass!). The switch next to it is a special switch that allows selection of either *symmetrical* or *non-symmetrical* addition/subtraction of the audio signal.

Linearization must not be the same for boost and cut curves because the ear reacts differently when *adding* a certain band of frequencies than when *subtracting* it. In reality, the most objectionable sounds are resonances. Therefore, a different response is required when *attenuating* frequencies than when *boosting* frequencies (one does not want to *create* a resonance!). The FM 133 therefore is set in the non-symmetrical position while the FM 233 allows selection of either symmetrical or non-symmetrical operation. The function of the controls are best illustrated with a few actual frequency response curves.

Fig. 1 shows the response with the symmetrical/non-symmetrical switch of the FM 233 in the *symmetrical* position (out) set at a 6 dB subtraction at 800 Hz. The result is a mild, musically pleasing correction curve.

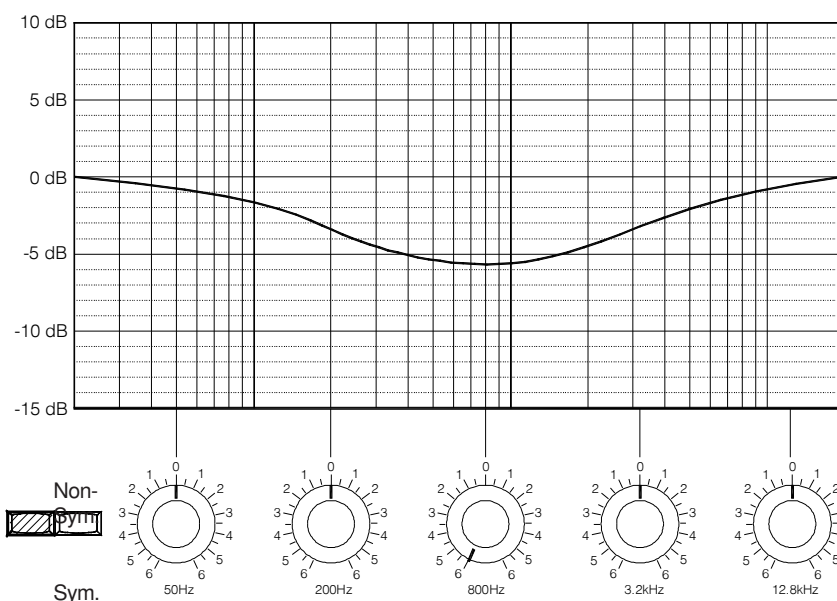

Fig.1

Fig. 2 shows the same setting of the Linearizer section but this time with the non-symmetrical switch pushed in (= the standard setting on the FM 133). The curve is quite distinctly different from that in Fig. 1 resulting in more concentrated correction in this non-symmetrical switch position.

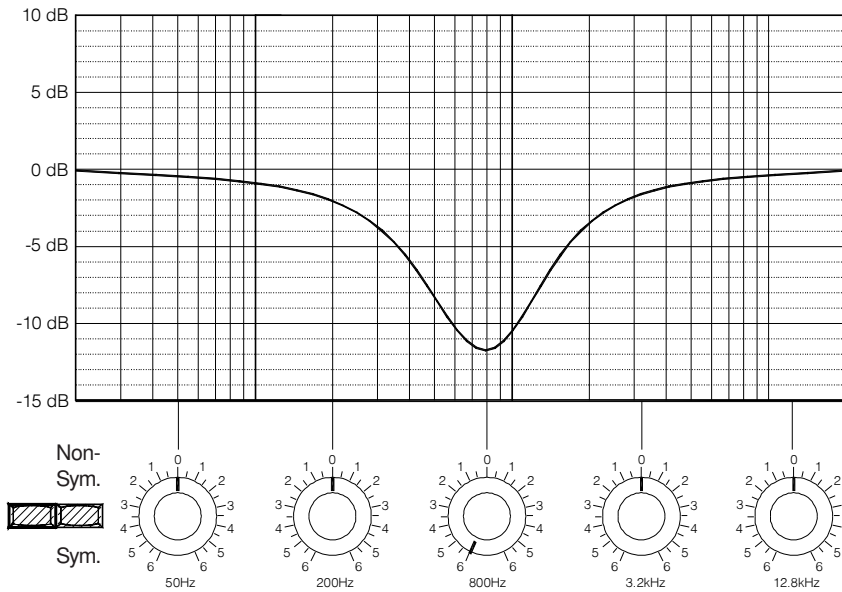

Fig.2

Fig. 3 shows signal addition at 800 Hz. This curve is identical for both the non-symmetrical as well as the symmetrical switch position. The reason for this is that the ear reacts different to a boost in frequency response than to an attenuation. Attenuated frequencies in music are often not sharp but rather soft and can be linearized by equally mild addition as Fig. 3 shows. Only a mild natural addition is what's needed.

This is another equalizer characteristic that all existing frequency range correction circuits do wrong. It is a unique feature of the FM 133 & FM 233 to have the possibility of linearizing signals in a *musically correct* way.

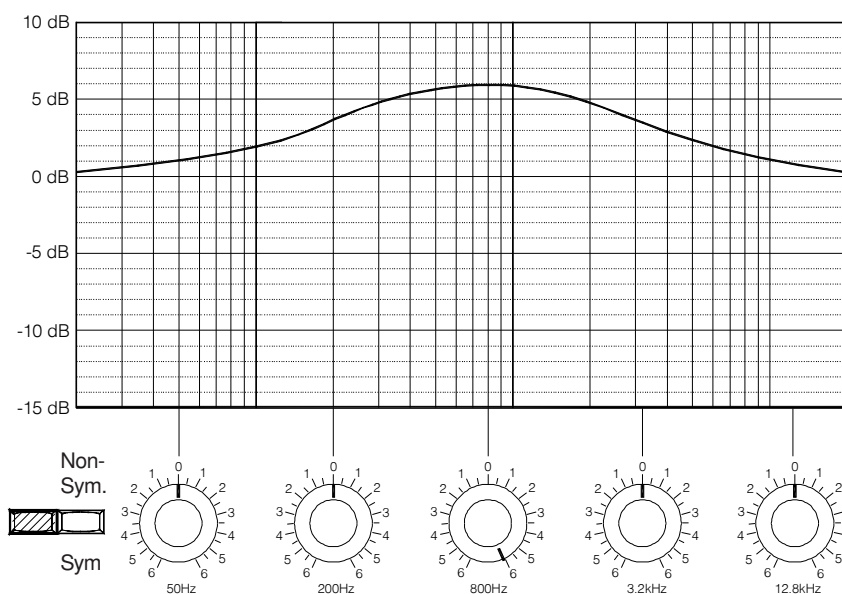

Fig.3

The curves following below show a number of even more exciting possibilities:

Fig. 4 shows - with the non-symmetrical switch on the FM 233 pushed in - the response when the 800 Hz and the 3.2 kHz band are subtracted from the direct signal (each is set at -3.6). As these are unique additive/subtractive Linearizers the Linearizer banks can be combined for an unlimited number of curves! Because of this combining possibility the numbers printed on the front panel do **not** correspond to an absolute dB level but are changing with settings of adjacent bands.

The smooth subtraction curve is centred exactly midway between the 800 Hz and the 3.2 kHz frequencies, at 1.6 kHz (in musical terms explained as precisely centered between the (lower and higher) octaves).

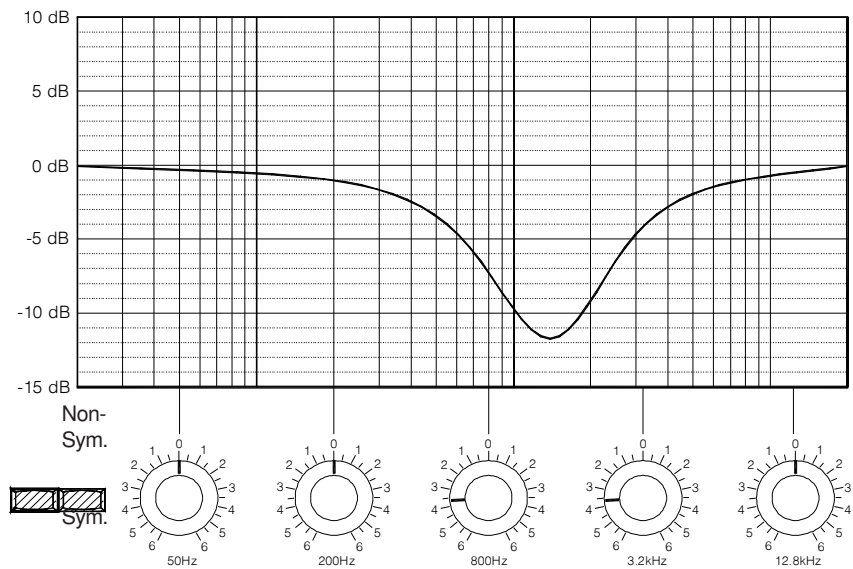

Fig.4

It is easy to see the absolutely smooth response ("no valleys or hills") as is usually the case (see below). Adjacent bands add perfectly without ripple or discontinuity. Transient reproduction is superb.

Compare this with **Fig. 5**, which shows the frequency response of a typical equalizer. Apart from the non-desirable response curve and the bad ripple in the pass band (that proves the existence of non-linearities), the phase response is terrible ruining a lot of what was on the original audio signal. There is some equalizing but it's at the wrong frequencies intermingled with huge phase errors and poor ripple.

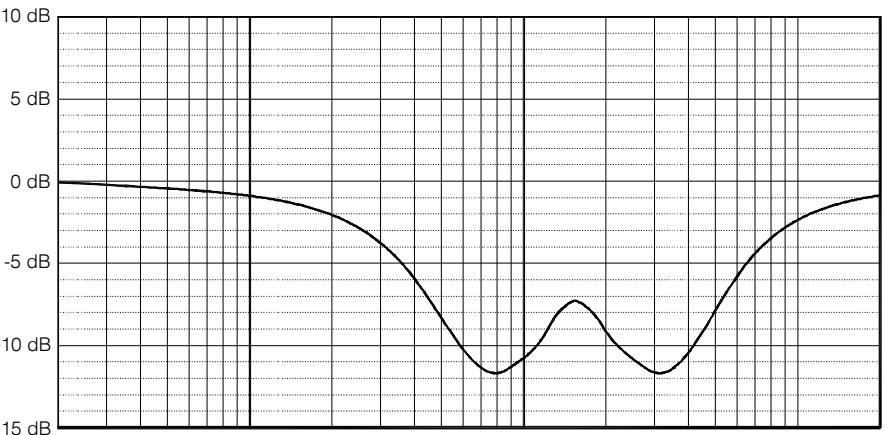

Fig.5

Fig. 5: Attenuation of a typical equalizer (not the Linearizer!) with frequency controls set as in Fig. 4.

Fig. 6: Another great feature of the unique FM 133 & FM 233 is that one is not limited to the five centre frequencies! If one would like to correct a signal aberration at say 1000 Hz, this is possible without resorting to poor sounding parametric/state-variable filters or other musically non-satisfactory circuits. By simply decreasing the subtraction at 3.2 kHz and increasing the subtraction at 800 Hz the center frequency now moves down to any frequency requested, in this setting to the required 1000 Hz!

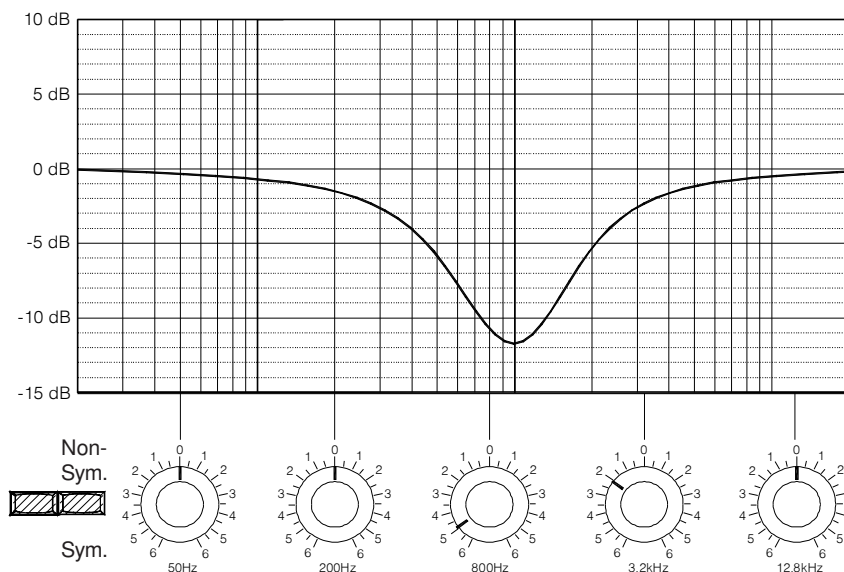

Fig.6

In this way it is possible to *select any frequency* in the audio band and at the same time continuously vary the level of subtraction or addition of these frequencies to whatever is required.

Remember, the attenuation can still be increased or decreased **at the same time** when changing the centre frequency, which allows unlimited control of the frequency addition and subtraction over the entire audio reproduction range! All with 5 controls!

Fig. 7 shows again the attenuation centered on 1 kHz but this time with less attenuation than in Fig. 6, both controls having been moved to somewhat less subtraction at 800 Hz and 3.2 kHz.

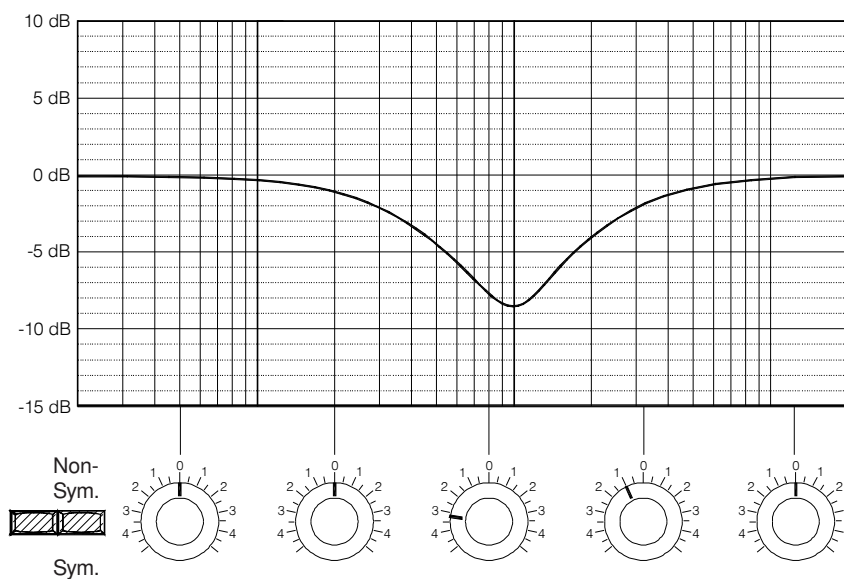

Fig.7

Fig. 8 displays the attenuation curve when two of the controls, in this case 200 Hz and 800 Hz, are set to *full subtraction* and the non-symmetrical switch is pushed in. This way one is able to achieve very pronounced attenuation.

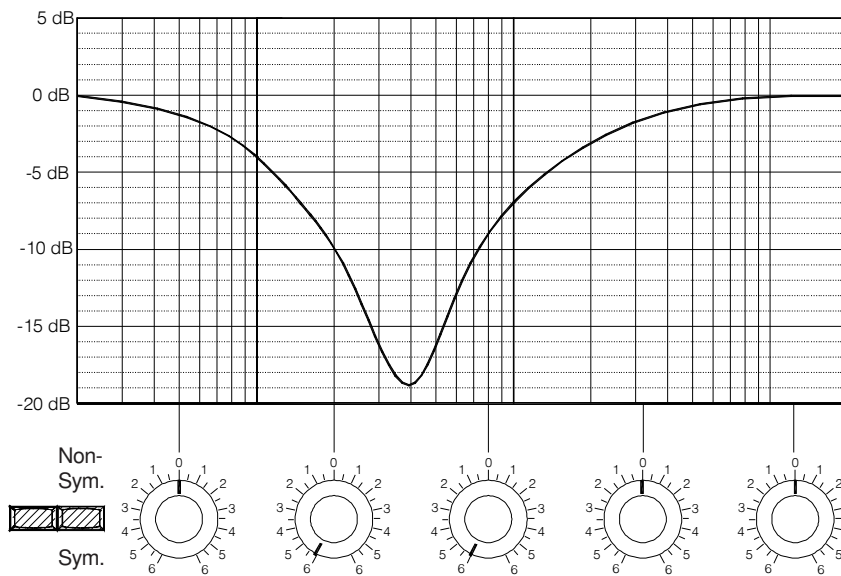

Fig.8

Note that as both controls are set to the same level of subtraction the centre frequency is at *exactly* the *harmonic middle* between the two controls (200 Hz and 800 Hz), in this case 400 Hz proving the musically correct function of the Linearizers.

FIG. 9 If, for instance, certain sharper resonances in a recording (e.g. horn resonances of early recordings) have to be subtracted from the original signal a good example is displayed in Fig. 9. Here the subtraction control is set to -6 at 800 Hz and -3.5 at both 200 Hz and 3.2 kHz. As can be seen, a resonance that - in this case - would be centred at 800 Hz could be subtracted from the direct signal with a profound attenuation of - in this case - 37 dB! Of course this is an extreme value not often required in actual use.

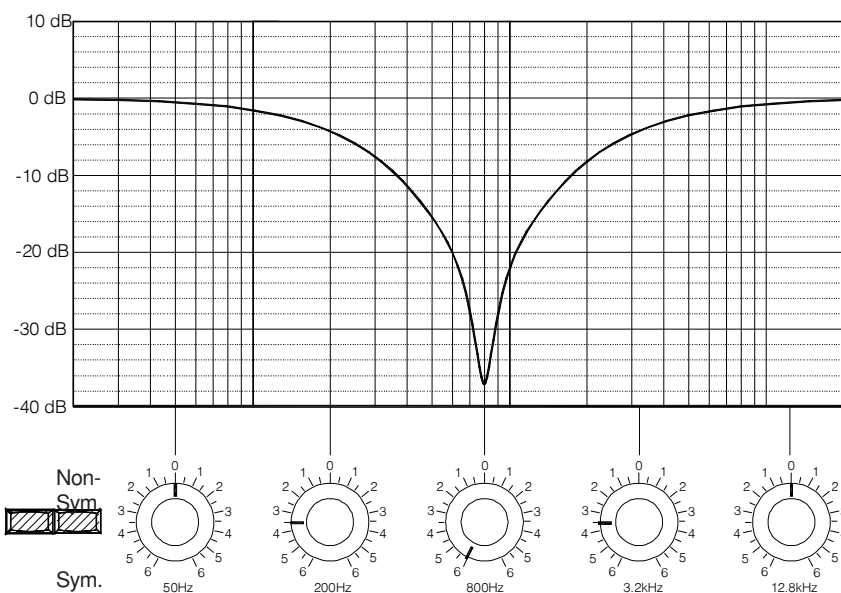

Fig.9

These figures only show a few of the myriad possibilities of the FM ACOUSTICS Harmonic Linearizers. The combination of just five dynamically interacting controls allows creating a literally *unlimited* number of musically relevant linearization/correction curves.

The FM 133 & FM 233 are *absolutely unique* as they allow *any* critical frequency in the audio band to be optimally linearized with just five dynamically interacting and easy to adjust controls, all of this done with FM ACOUSTICS pure discrete class A analogue circuitry.

Correction of errors - without negatively affecting the audio signal - and literally let the signal pass through *directly without filtering* has finally become reality.

Now it is possible to achieve tremendous improvements in the weakest part of the audio reproduction chain: the source signal.

AV and Home Theatre application

The FM 133 & FM 233 are ideally suited to linearize any source used in AV and home theatre systems. In these systems, the majority of the sound comes from the two main speakers left and right of the screen. By leading these L + R signals through the FM 133 or FM 233 it is possible to improve the reproduction amazingly.

There is no need for a 5-, 6- or 7- channel correction unit as the critical full-range signal comes through the two frontal channels. By linearizing these, amazing improvements can be achieved.

Phono Linearization

The FM 133 & FM 233 have a different function than the FM 123 & FM 223 Phono Linearizers, which can create a precise mirror image of the many different pre-emphasis curves which were used by the various record companies.

By adjusting the "Turnover Frequency" and the "10 kHz Attenuation" knobs on the frontpanel of the FM 123 & FM 223 the reproduction of *any LP ever made* can be linearized. To be able to fully comprehend the amazing improvement, the FM ACOUSTICS phono Linearizers really must be heard replaying records of the golden age.

The FM 133 & FM 233 Harmonic Linearizers complement a system which is using either FM 123 or FM 223 phono linearizers as they are able to linearize critical signal frequencies in download servers, CD, DVD etc. as well as LP's. For instance, certain LP's contain resonances or have a coloured sound because some frequencies of the music spectrum were amplified excessively, there were uncontrolled resonances, the microphones were not positioned correctly or there were other problems in recording and/or mastering. Many a recording that is suffering from such problems can be linearized with the FM 133 & the FM 233 which will provide an entirely different listening experience.

Room Acoustics

The FM 133 & FM 233 are not designed for compensation of room acoustic problems, (although improvements are possible). The FM 133 & FM 233's task is the *linearization* of the *source* signal.

CONNECTING CABLES to and from the FM 133

All specifications were obtained by using *Precision Interface Technology*[®] cables. Optimal performance can only be achieved by using the following types of *Precision Interface Technology*[®] cables:

Note: the last digit "_" indicates the length of the cable e.g.:

2501 1 = 0.6 m	2501 3 = 3 m
2501 2 = 1.2 m	2501 4 = 5 m

CABLES TO INPUTS FM 133

CA 2501x is to be used when connecting single-ended equipment to the inputs



CA 2503x is to be used when connecting pseudo-balanced equipment to the inputs of the FM 133



CA 2504x is to be used when connecting true balanced equipment to the inputs of the FM 133



OUTPUT CABLES FM 133

CA 2501x is to be used when connecting single-ended equipment to the outputs



CA 2502x is to be used when connecting the outputs to balanced equipment

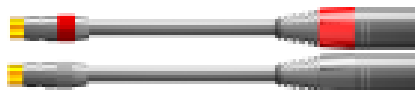

CONNECTING CABLES to and from the FM 233

All specifications were obtained by using *Precision Interface Technology*® cables. Optimal performance can only be achieved by using the following types of *Precision Interface Technology*® cables:

Note: the last digit "_" indicates the length of the cable e.g.:

25011 = 0.6 m	25013 = 3 m
25012 = 1.2 m	25014 = 5 m

CABLES TO INPUTS FM 233

CA-2502x is to be used when connecting unbalanced sources to the input of the FM 233

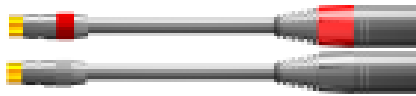

CA-2509x is for connection from pseudo-balanced sources to the FM 233 true balanced inputs

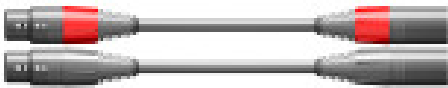

CA-2510x is for connection from balanced earth-free sources to the FM 233 true balanced inputs

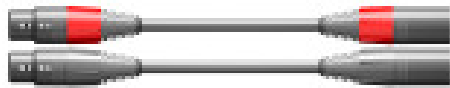

OUTPUT CABLES FM 233

CA-2510x is for connection to true balanced loads

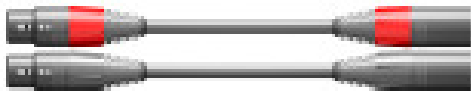

CA-2504x is for connection to unbalanced loads having Phono/RCA connectors



SPECIFICATIONS

FM 133 & FM 233 HARMONIC LINEARIZERS

When choosing a product do not simply compare specifications sheets! Specifications are often misused, misunderstood or utilised only to sell a product instead of indicating its actual performance capabilities.

“Typical” specifications will not tell you much about the true value of a certain component. Only **guaranteed minimum specifications** as indicated below, together with carefully controlled listening tests, will show the differences and will permit to make the correct choice.

The guaranteed specifications indicate the absolutely unique standard of these Harmonic Linearizers and show those performance aspects that are measurable. But words simply cannot describe the truly breathtaking reproduction of FM ACOUSTICS Harmonic Linearizers. Only a controlled audition will reveal the facts.

All specifications are guaranteed minimum data for every single unit. Individual detailed test reports are completed and filed at FM ACOUSTICS for reference.

Circuitry:

Proprietary discrete, enhanced Class A circuitry using hand-selected semiconductors. These are individually analysed and then subjected to FM ACOUSTICS' unique selection processes. The entire unit is crafted with FM ACOUSTICS hand calibrated precision Class A circuits.

Inputs:

FM 133: single ended high-level and tape return inputs on RCA/Phono connectors.

FM 233: Fully symmetrical, balanced discrete Class A circuitry, floating ground, non-inverting or inverting connection; works perfect with any balanced as well as unbalanced source.

Unbalanced and pseudo-balanced signals are automatically converted to true balanced symmetrical signals right at the inputs of the FM 233. Sensors recognize what connection standard is employed and assure optimal interfacing to whatever unit is connected.

Interference rejection FM 233:

Guaranteed better than 90dB.
Typically better than 100 dB (100-1000 times better than other "balanced" electronics.

Input impedance:

FM 133: 80 kOhm
FM 233: 100 kOhm from both balanced and unbalanced loads; absolutely linear

Headroom:

FM 133: +20 dBv (22V^{PP})
FM 233: +21 dBv (25V^{PP})

Gain:

Input to Output: 0 dB.

Frequency response:

FM 133: 20 Hz - 20 kHz +/- 0.09 dB
FM 233: 20 Hz - 20 kHz +/- 0.03 dB

Stereo separation:

Better than 85 dB

Channel separation:

Better than 95 dB

Bandwidth:

Without RF filter: 1 Hz - 2 MHz
With internal RF filter: 1 Hz - 100 kHz
The actual frequency response of the Linearizer, however, is intentionally attenuated above 100 kHz with a linear-phase anti-RF circuit. For special application this could be bypassed.

Phase accuracy:

Without RF filter: better than -0° / +1° over full frequency range from 20 Hz - 20 kHz

Step response:

Perfect with no overshoot or ringing

Rise time:

300 nanoseconds = 0,3 uSec.
(capability of electronics, measured without RF filter)

Fall time:

300 nanoseconds = 0,3 uSec.
(capability of electronics, measured without RF filter)

Hum and Noise:

FM 233: Better than -120 dB below full output 20 Hz - 20 kHz

Output:

FM 133: Single ended main output plus tape loop output on RCA/Phono connectors. Can drive any balanced or unbalanced load

FM 233: true symmetrical, balanced, discrete Class A circuitry. Can drive any balanced or unbalanced load. Sensors automatically adjust output to optimal performance with whatever unit is connected; balanced or unbalanced.

Max. Output level:

FM 133: +20 dBv (22 V^{PP})
FM 233: +28 dBv (55 V^{PP})
into 4,7 kOhm balanced load

Harmonic Distortion:

FM 133: 0.01%
 FM 233: over full frequency range 0,003% at
 3 V out.
 No higher order harmonics up to clipping
 level

Operating Mains voltage:

Stable operation within a voltage range of:
 95 V to 140 V (115 V nominal setting)
 190 V to 280 V (230 V nominal setting)

Power consumption:

FM 133: 7W continuous
 FM 233: 15 W continuous

Operating temperature:

0°C to +40°C

Operating humidity:

Long-term: 0 - 85%
 Short-term: 0 - 95%
 continuous high humidity may shorten lifetime
 of certain components somewhat

Burn-in time at factory:

500 thermal cycles, minimum 100 hours

Vibration test at factory:

50'000 vibration cycles, minimum 60 minutes

Average Live expectancy:

36 years (at 25°C ambient, 10 hours per
 day, 365 days per year)

Front panel:

5 mm laser cut, brushed and then hand-
 polished aluminium; wear-proof lettering;
 precision centered variable frequency
 Linearizer controls; bypass switch, POWER ON
 switch & indicator.

On FM 133: tape monitor loop switch

On FM 233: symmetrical/non-symmetrical switch

Back panel:

4 mm brushed and hand-polished aluminium,
 wear-proof lettering.

All inputs and outputs of FM 133 are
 precision RCA/Phono receptables.

On FM 233 inputs and outputs are profes-
 sional XLR-connectors.

Chassis connected to mains earth wire to
 avoid groundloops.

4-Pin power supply connector on FM 133.

Spare parts availability:

Min. 10 years; guaranteed availability of
 99.8% of all parts ex stock.

Connectors:**FM 133:**

Inputs & Outputs: RCA / Phono receptables

FM 233:

Input: female XLR 3-pin

non-inverting: Pin 1: ground

Pin 2: (return) cold

Pin 3: (signal) hot

inverting: Pin 1: ground

Pin 2: (signal) hot

Pin 3: (return) cold

Outputs:

male XLR 3-pin

balanced: Pin 1: ground

Pin 2: (return) cold

Pin 3: (signal) hot

Dimensions:

FM 133: 245 mm w / 62 mm h / 290 mm d

FM 233: 446 mm w / 45 mm h / 280 mm d

Weight:

FM 133: 2.2 kg net

FM 102 power supply: 1 kg net

Packed together: 5.5 kg net / 7 kg packed

FM 233: 6 kg net / 8 kg packed

Applications:

Reference Harmonic Linearizers for music repro-
 duction systems in professional applications such
 as recording studios, mastering studios, film re-
 cording and reproduction, audio-video, cinema,
 theatre, music instrument, P.A. and a variety of
 domestic applications.

IEC, DIN and MIL (military) standards of components used:

IEC 68=55/155/56	DIN 384-4	MIL-R-STD 202 Method
IEC 68=55/085/21	DIN 40040	01, 103, 106, 213, 301
IEC 144/IP 65	DIN 40046	MIL-R-11804/2B/G
IEC 40/100/56	DIN 40050 P 54	MIL-R-22097
IEC 115-1	DIN 41332 Type IIA	MIL-R-10509
IEC 384-9	DIN 44112	MIL-R-55182
IEC 384-8 IB	DIN 44356	MIL-R-2133 & 2334
IEC 384-2	DIN 45910 Part 1201	MIL-R-45204 Type 2
IEC 68: 55/085/56	DIN 45921-107	MIL-R-23285
IEC 68: 55/200/56	DIN 44061	MIL-C-19978 B
IEC 68: 2-6		MIL-VG-95-295
		MIL-S-23190 R.I.N.A.
		Nr. 5/206/85

The choice of leading artists

**FM ACOUSTICS LTD.**

CH-8132 Egg b. Zurich
 Switzerland

Telephone: ..41/44/725 77 77

Facsimile: ..41/44/725 77 90

www.fmacoustics.com

Due to continuous research on existing products, FM ACOUSTICS LTD. reserves the right to change specifications without further notice.